

SECTION VIEW - ANTIFLOTATION BASE

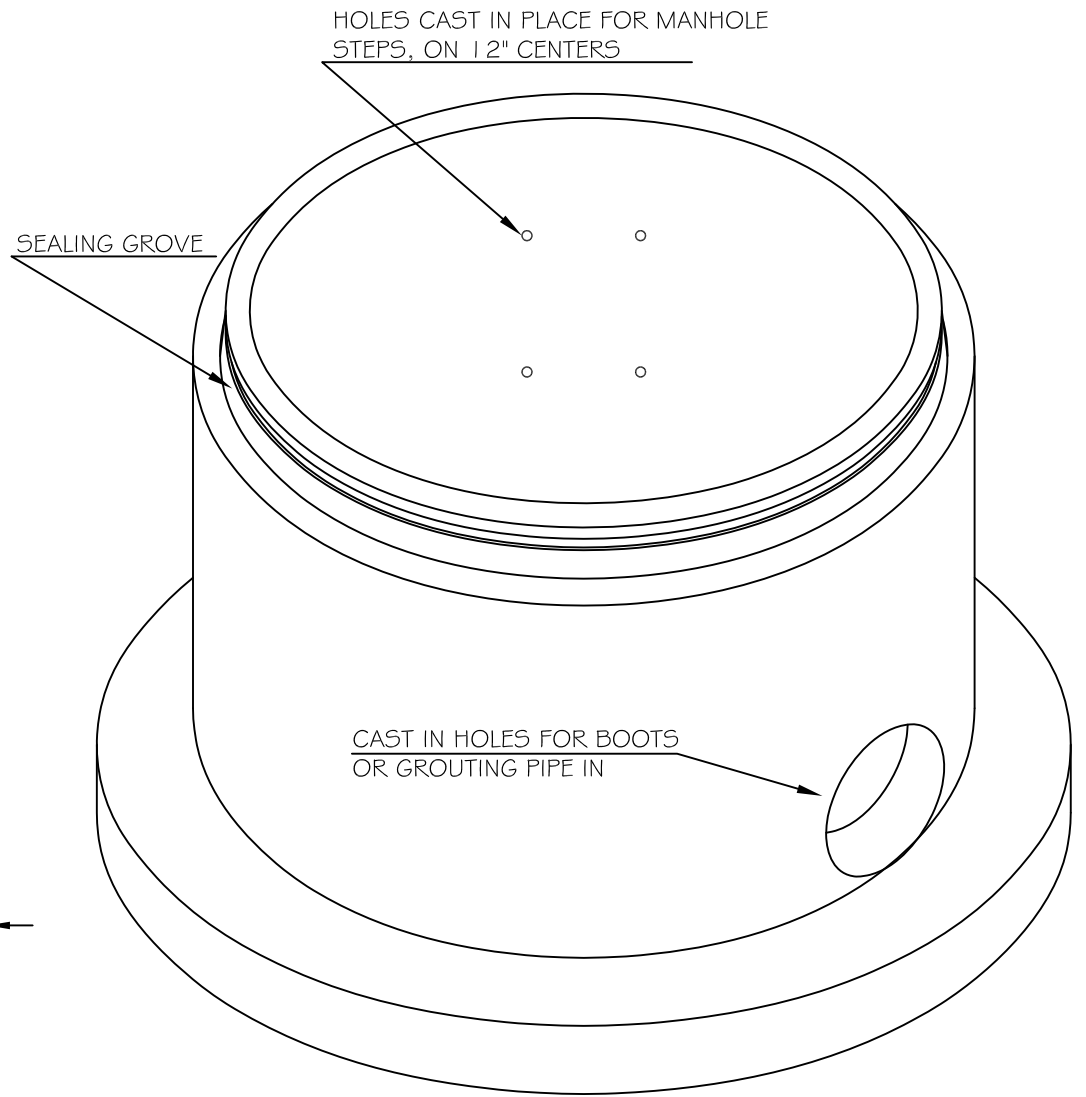

ISOMETRIC VIEW

NOTE:
MANHOLE BASES ARE MANUFACTURED
TO ASTM C-478-90B SPECIFICATIONS



PHONE: 800-837-8918
FAX: 304-464-4013

CARR CONCRETE
CARR CONCRETE CORPORATION
P.O. BOX 265, WAVERLY, WV 26184-0265

MANHOLE ANTIFLOTATION BASE 48" DIA.

DWG. NO.	
1	
OF	
1	
REV	DATE

FILE# DRAWN BY KJK DATE 4/13/2012