

HOLES CAST IN PLACE FOR MANHOLE
STEPS, ON 12" CENTERS

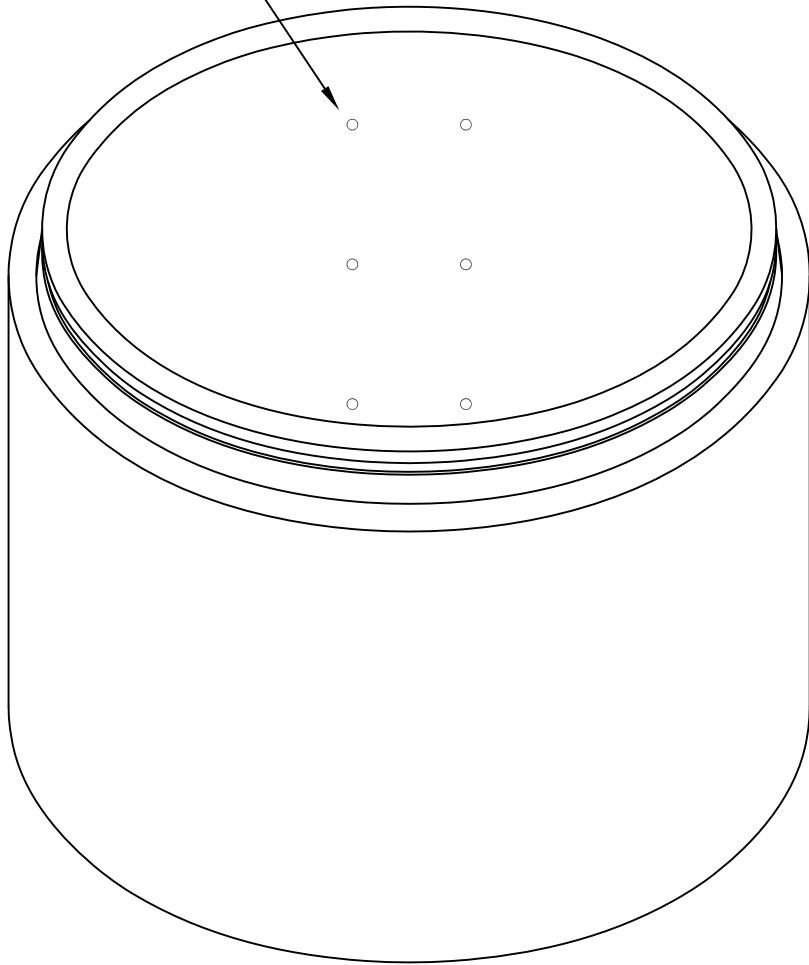

ISOMETRIC VIEW

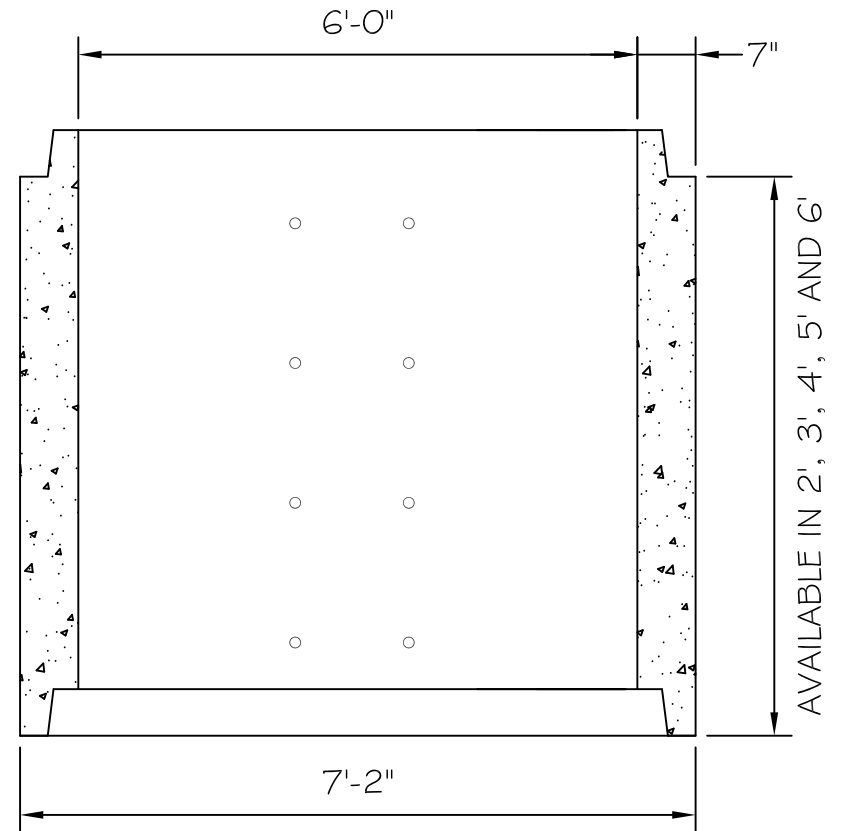

SECTION VIEW

NOTE:
MANHOLE RISERS ARE MANUFACTURED
TO ASTM C-478-90B SPECIFICATION

 <p>PHONE: 800-837-8918 FAX: 304-464-4013 CARR CONCRETE CARR CONCRETE CORPORATION P.O. BOX 265, WAVERLY, WV 26184-0265</p>	MANHOLE RISER 72" DIA			DWG. NO.		
				1		
				OF		
				1		
FILE#	DRAWN BY	KJK	DATE	4/13/2012	REV	DATE